

INSTRUCTION MANUAL

For

**BULK CURRENT
INJECTION PROBE**

Model: **CLCI-400**

and

CALIBRATION FIXTURE

Model: **FCLC-400**

(optional)



Table of Contents

1. Introduction.....	5
2. Products Available from Com-Power.....	6
3. Product Information.....	7
3.1 Incoming Inspection.....	7
3.2 Package Inventory.....	7
3.3 Product Safety Information.....	8
3.3.1 Product Hazard Symbols Definitions.....	8
3.3.2 Product Warning/Caution Statements.....	8
3.3.3 General Safety Instructions.....	8
3.4 Product Features.....	9
3.4.1 CLCI-400 Bulk Current Injection Probe Features.....	9
3.4.2 FCLC-400 Calibration Fixture Features.....	10
3.5 Product Specifications.....	11
3.5.1 CLCI-100 Bulk Current Injection Probe Specifications.....	11
3.5.1 FCLC Calibration Fixture Specifications.....	11
3.6 Product Dimensional Diagrams.....	12
3.6.1 Dimensions of CLCI-400 Bulk Current Injection Probe.....	12
3.6.2 FCLC Calibration Fixture Dimensional Drawing.....	13
3.7 Typical Performance Data.....	14
4. Calibration.....	16
4.1 Installation of CLCI-400 Probe into FCLC-400 Fixture.....	16
4.2 Insertion Loss/Transfer Impedance Calibration.....	17
4.2.1 Insertion Loss.....	17
4.2.2 Transfer Impedance Factors.....	18
5. Calibration & Test Procedures – MIL-STD-461G (CS114).....	19
5.1 Test Frequencies.....	19
5.2 Test Levels.....	20
5.3 Test Level Calibration Procedure.....	21
5.4 Verification of Calibration Test Levels Procedure.....	22
5.5 EUT Testing Procedure.....	23
6. Calibration & Test Procedures – RTCA DO-160G (Section 20).....	25
6.1 Test Frequencies.....	25

- TABLES OF CONTENTS -

6.2	Test Levels.....	26
6.3	Test Level Calibration Procedure	27
6.4	EUT Testing Procedure.....	28
7.	Warranty	29
8.	Maintenance.....	30

List of Figures

Figure 1 – CLCI-400 Bulk Current Injection Probe Features	9
Figure 2 – FCLC-400 Calibration Fixture Features	10
Figure 3 – CLCI-400 Bulk Current Injection Probe Dimensions	12
Figure 4 – FCLC-400 Calibration Fixture Dimensions.....	13
Figure 5 – Typical Insertion Loss for CLCI-400.....	14
Figure 6 – Typical Transfer Impedance Factors for CLCI-400.....	14
Figure 7 – Typical VSWR of FCLC-400 Calibration Fixture	14
Figure 8 – Typical Forward Power Levels for MIL-STD-461 (CS114)	15
Figure 9 – Typical Forward Power Levels for RTCA DO-160 (Section 20).....	15
Figure 10 – Installation of CLCI-400 Probe into FCLC-400 Fixture	16
Figure 11 – Equivalent Schematics of the Insertion Loss Calibration Circuits.....	17
Figure 12 – Test Setup for Insertion Loss Measurement	18
Figure 13 – Calibration Levels – MIL-STD-461G (CS114)	20
Figure 14 – Example Test Setup Diagram for Calibration of Test Levels.....	21
Figure 15 – Example Test Setup Diagram for Verification of Calibration Test Levels	22
Figure 16 – Example Test Setup Diagram for EUT Testing.....	23
Figure 17 – Calibration Limits – RTCA DO-160G	26
Figure 18 – Example Test Setup Diagram for Calibration of Test Levels.....	27
Figure 19 – Example Test Setup Diagram for EUT Testing.....	28

List of Tables

Table 1 – CLCI-400 Bulk Current Injection Probe Specifications	11
Table 2 – FCLC-400 Calibration Fixture Specifications.....	11
Table 3 – Test Frequency Step Size Calculations as per MIL-STD-461, Table III.....	19
Table 4 – Example Test Frequency List – MIL-STD-461G (CS114).....	19
Table 5 – Calibration Levels – MIL-STD-461G (CS114)	20
Table 6 – Maximum Current Levels – MIL-STD-461G (CS114)	23
Table 7 – Example Test Frequency List – RTCA DO-160G	25
Table 8 – Calibration Limits – RTCA DO-160G	26

1. Introduction

This manual includes description of product features, typical electrical performance parameters, product specifications, instructions for use, and step by step procedures for calibration of test levels and performing testing. Also included are important safety precautions, warranty and maintenance information.

The test procedures and guidance provided herein is for general guidance and is correct based on our understanding of the current, relevant standards at the time that this manual was written. However, the information may become dated or may be inappropriate for some applications.

The user is cautioned to refer and adhere to the appropriate standards, rules, procedures, practices, and/or relevant interpretations thereof for your application in order to ensure proper application of the test.

Information contained in this manual is the property of Com-Power Corporation. It is issued with the understanding that the material may not be reproduced or copied without the express written permission of Com-Power.

2. Products Available from Com-Power



Antennas



Antenna Kits



Absorbing Clamps



Coupling/Decoupling Networks (CDNs)



Comb Generators



Current Probes & Injection Probes



Emissions Test Systems



Conducted Immunity Test Systems



Impedance Stabilization Networks (ISNs)



Line Impedance Stabilization Networks (LISNs)



Antenna Masts



Near-Field Probe Sets



Preamplifiers



Power Amplifiers



Spectrum Analyzers



Surge Generators



Transient Limiters



Turntables



Antenna Tripods



Telecom Test Systems

www.com-power.com

SECTION 2 - PRODUCTS AVAILABLE FROM COM-POWER

3. Product Information

3.1 Incoming Inspection



If shipping damage to the product or any of the accessories is suspected, or if the package contents are not complete, contact Com-Power or your Com-Power distributor.

Please check the contents of the shipment against the package inventory in section 3.2 to ensure that you have received all applicable items.

3.2 Package Inventory

STANDARD ITEMS:

- ✓ CLCI-400 Bulk Current Injection Probe
- ✓ Calibration Certificate and Associated Data

OPTIONAL ITEMS:

- ✓ FCLC-400 Calibration Fixture
- ✓ ADA-515-2 150Ω to 50Ω Adapter Set
- ✓ ATTN-6-100W Power Attenuator (6 dB, 100W)
- ✓ ATTN-30-100W Power Attenuator (30 dB, 100W)
- ✓ TERM-100W Termination (50Ω)
- ✓ DCD-1000-100W Dual Directional Coupler

3.3 Product Safety Information

3.3.1 Product Hazard Symbols Definitions

The hazard symbols appearing on the product exterior are defined below.



The yellow triangle with an exclamation mark indicates the presence of important operating and/or maintenance (servicing) instructions in the literature accompanying the product.

3.3.2 Product Warning/Caution Statements

The following warnings/caution statements must be adhered to in order to ensure safe operation of the product.



CAUTION:

Hazardous Voltages present during operation. Do not handle probe while test is in progress.

3.3.3 General Safety Instructions

The following safety instructions have been included in compliance with safety standard regulations. Please read them carefully.



- **READ AND RETAIN INSTRUCTIONS** - Read all safety and operating instructions before operating the instrument. Retain all instructions for future reference.
- **HEED WARNINGS** - Adhere to all warnings on the instrument and operating instructions.
- **FOLLOW INSTRUCTIONS** - Follow all operating and use instructions.
- **WATER AND MOISTURE** - Do not use the instrument near water.
- **HEAT** - The instrument should be situated away from heat sources such as heat registers or other instruments which produce heat.
- **CLEANING** - Clean the instrument outside surfaces of the device with a soft, lint-free cloth. If necessary, a mild detergent may be used.
- **NON-USE PERIODS** - Unplug the power cords of the instrument when it will be left unused for a long period of time.
- **OBJECT AND LIQUID ENTRY** - Take care that objects do not fall into the instruments and that liquids are not spilled into the enclosure through openings.
- **DEFECTS AND ABNORMAL STRESS** - Whenever it is likely that the normal operation has been impaired, make the equipment inoperable and secure it against further operation.
- **SITTING OR CLIMBING** - Do not sit or climb upon the instrument or use it as a step or ladder.
- **ENVIRONMENTAL CONDITIONS** - This equipment is designed for indoor use. Ambient temperature range during operation should be between 5° C to 40° C.
- **STORAGE AND PACKAGING** - The device should only be stored at a temperature between -25 and +70 °C. During extended periods of storage, protect the device from dust accumulation. The original packaging should be used if the device is transported or shipped again. If the original packaging is no longer available, the device should be packed carefully to prevent mechanical damage.

SECTION 3 - PRODUCT INFORMATION

3.4 Product Features

3.4.1 CLCI-400 Bulk Current Injection Probe Features

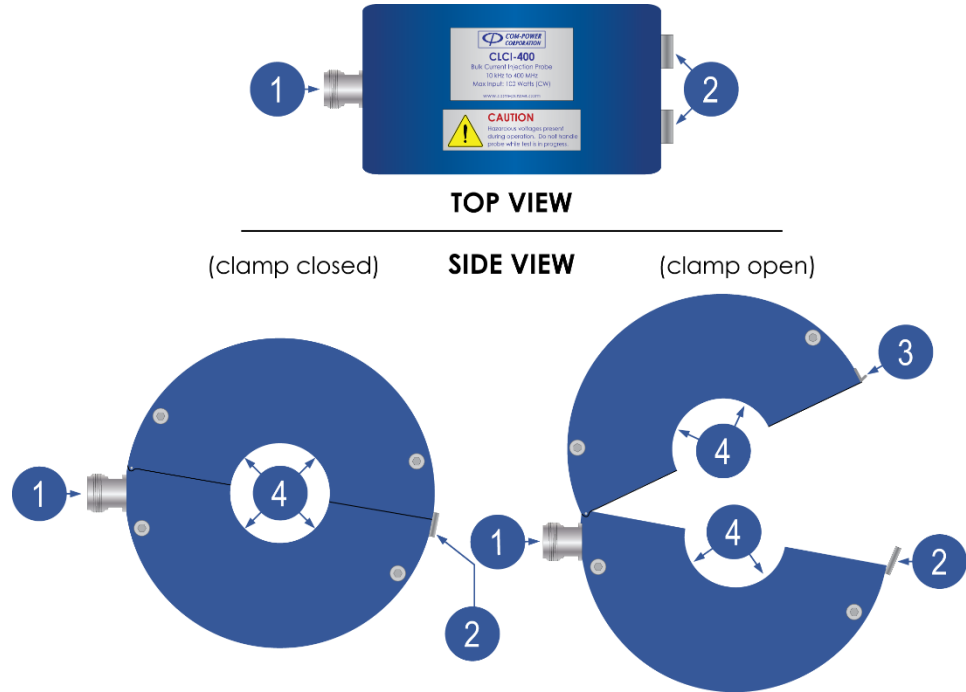

Figure 1 – CLCI-400 Bulk Current Injection Probe Features

- 1 Input/Output Port**
When used for bulk current injection, this is the input port of the probe. When used as a measuring device, this is the probe's output port. It is fitted with an N-type coaxial connector.
- 2 Spring-loaded Clasps**
These two (2) clasps, when secured over their respective brackets, lock the clamp into its closed position.
- 3 Clasp Brackets**
These two (2) brackets anchor the respective clasps in order to lock the clamp into its closed position.
- 4 Clamp Window**
This clamp window is the aperture in the center of the clamp through which the wire(s), cable(s) or cable bundle(s) to be tested are passed through.

SECTION 3 - PRODUCT INFORMATION

3.4.2 FCLC-400 Calibration Fixture Features

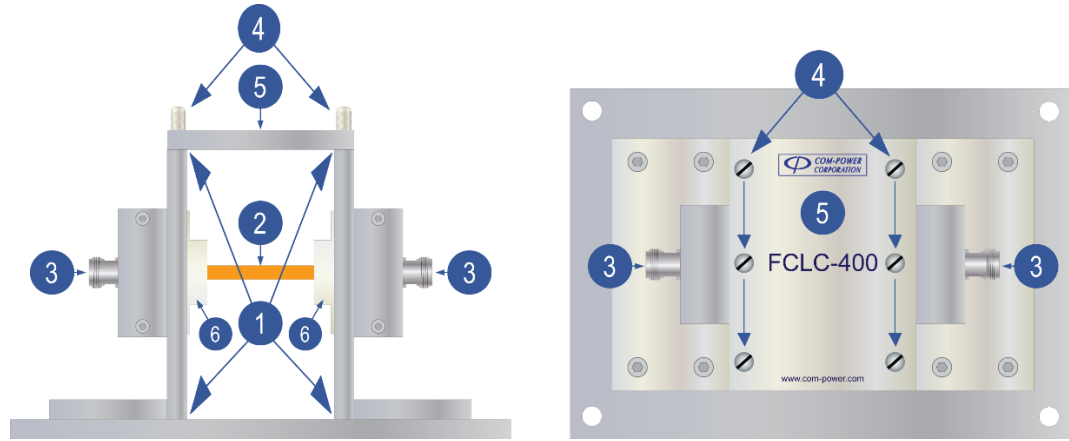

Figure 2 – FCLC-400 Calibration Fixture Features

- 1 Fixture Opening**
The CLCI-400 is installed within this opening so that the center conductor rod of the fixture passes through the approximate center of the probe aperture.
- 2 Center Conductor Rod**
This is the fixture's center conductor.
- 3 Calibration Fixture Coaxial Ports**
These are female N-type coaxial connectors providing input/output connections to the fixture.
- 4 Thumb Screws for Removable Top Plate**
These (6) screws secure the fixture's top plate to the fixture assembly.
- 5 Removable Top Plate of Fixture**
In order to install/remove the clamp into/from the calibration fixture, the top plate must be removed by removing the six (6) thumb screws. The top cover and thumb screws must be replaced prior to the performance of tests.
- 6 Teflon Spacers**
These spacers help in centering the clamp within the fixture; and thereby aligning the center conductor through the center of the probe window.

3.5 Product Specifications

3.5.1 CLCI-100 Bulk Current Injection Probe Specifications

Table 1 – CLCI-400 Bulk Current Injection Probe Specifications

Product	Bulk Current Injection Probe
Model	CLCI-400
Frequency Range	10 kHz to 400 MHz
Standard(s)	MIL-STD 461, RTCA-DO-160
Impedance	50Ω (nominal)
Maximum Input Power	100 Watts (continuous)
Coaxial RF Connector	N-type (female)
Dimensions (H)x(W)x(D)	5" x 2.75" x 5.75" (12.75 x 7 x 14.6 cm)
Probe Window Diameter	1.575" (4 cm)
Weight	4.5 lbs. (2.04 kg)
Operating Temperature	40°F to 104°F (5°C to 40°C)

All values are typical, unless specified.
 All specifications are subject to change without notice.

3.5.1 FCLC Calibration Fixture Specifications

Table 2 – FCLC-400 Calibration Fixture Specifications

Product	Calibration Fixture	
Model	FCLC-400	
Frequency Range	10 kHz to 400 MHz	
Standard(s)	MIL-STD 461, RTCA-DO-160	
Impedance	50Ω (nominal)	
VSWR	0.01-50 MHz	≤ 1.05 : 1
	50-150 MHz	≤ 1.2 : 1
(empty fixture – no probe installed)	150-200 MHz	≤ 1.35 : 1
	200-300 MHz	≤ 2 : 1
	200-350 MHz	≤ 2.5 : 1
	350-400 MHz	≤ 3 : 1
Coaxial RF Connectors	(2) N-type (female)	
Dimensions (H)x(W)x(L)	6.6" x 7" x 10" (16.7 x 18 x 25.5 cm)	
Weight (empty fixture)	8 lbs. (3.63 kg)	
Max. Probe Diameter	5.2" (13.2 cm)	
Min. Probe Aperture Diameter	0.79" (2 cm)	
Max. Probe Width	2.83" (7.2 cm)	
Operating Temperature	40°F to 104°F (5°C to 40°C)	

SECTION 3 - PRODUCT INFORMATION

3.6 Product Dimensional Diagrams

3.6.1 Dimensions of CLCI-400 Bulk Current Injection Probe

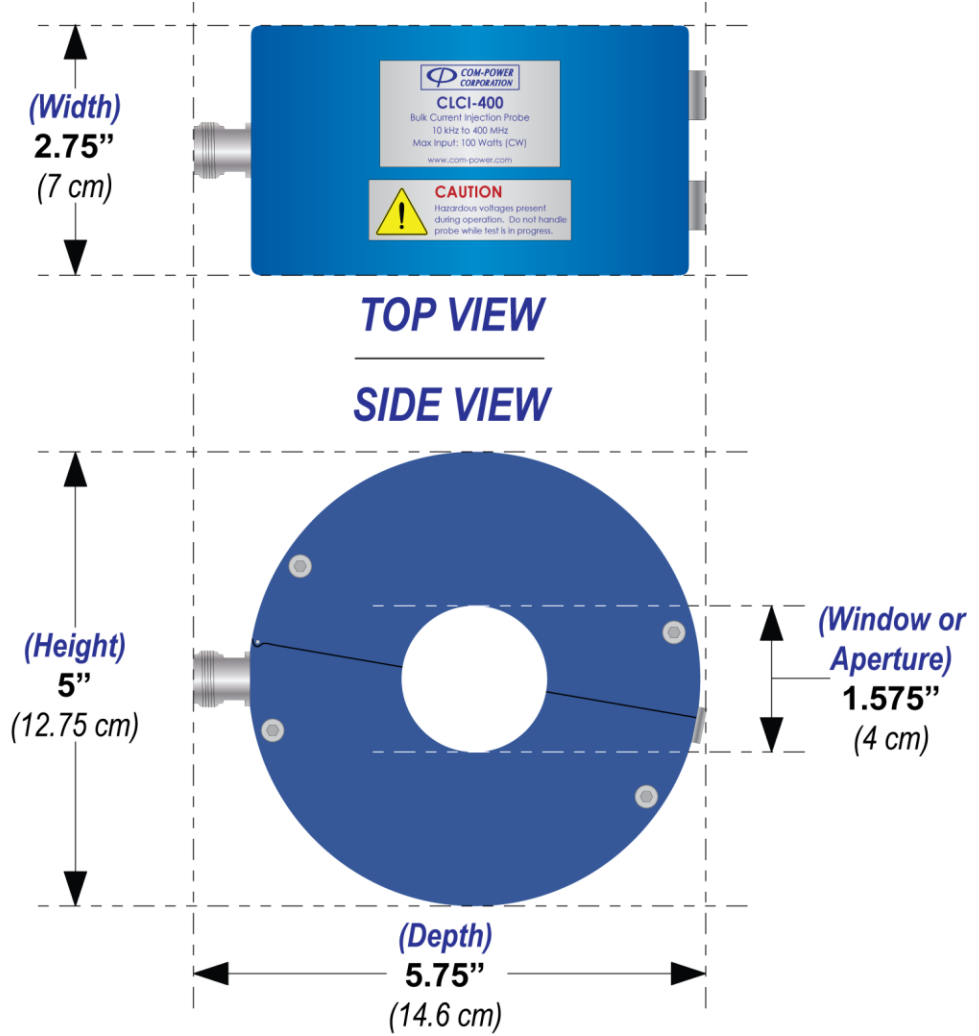

Figure 3 – CLCI-400 Bulk Current Injection Probe Dimensions

3.6.2 **FCLC Calibration Fixture Dimensional Drawing**

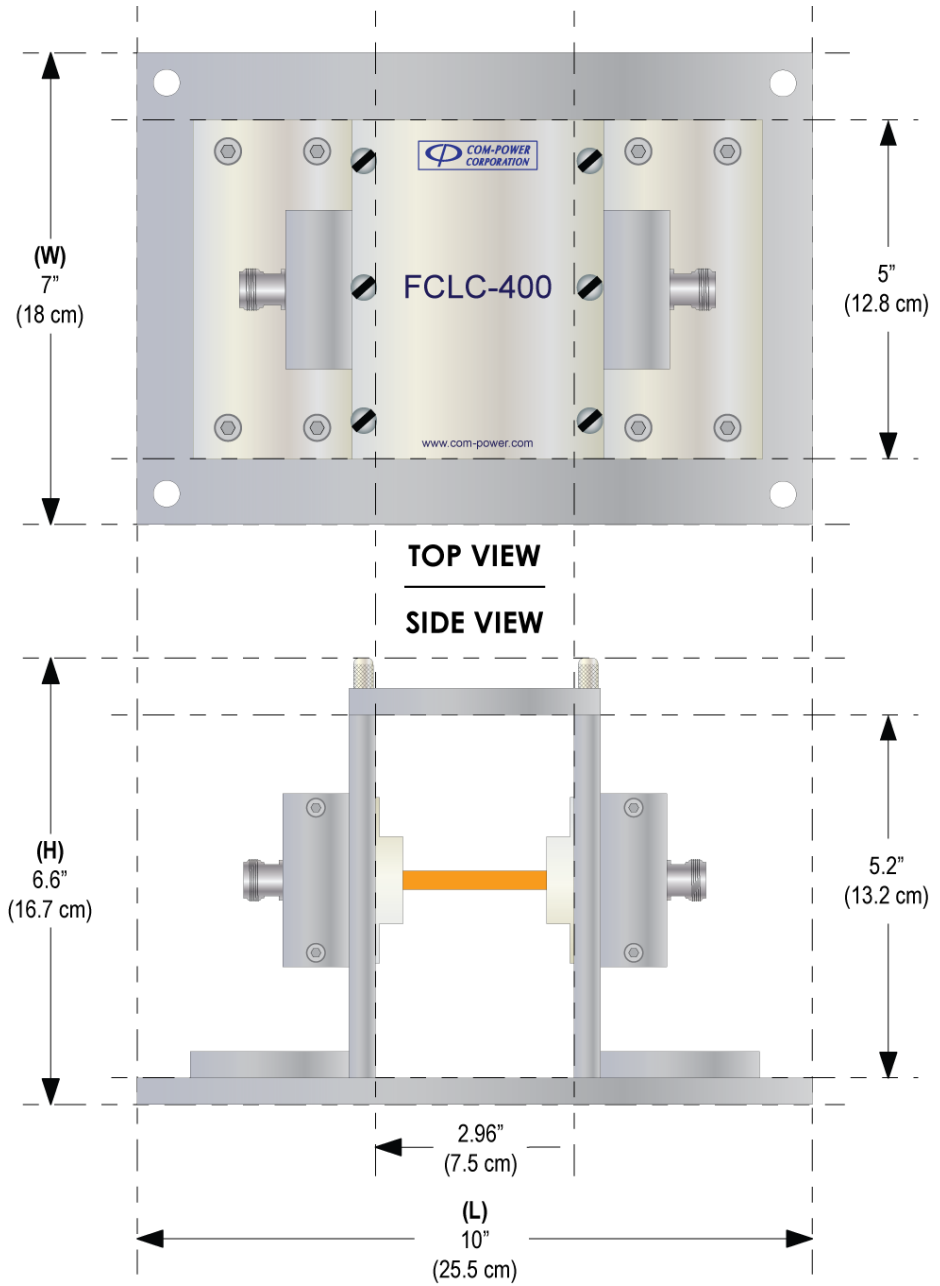

Figure 4 – FCLC-400 Calibration Fixture Dimensions

SECTION 3 - PRODUCT INFORMATION

3.7 Typical Performance Data

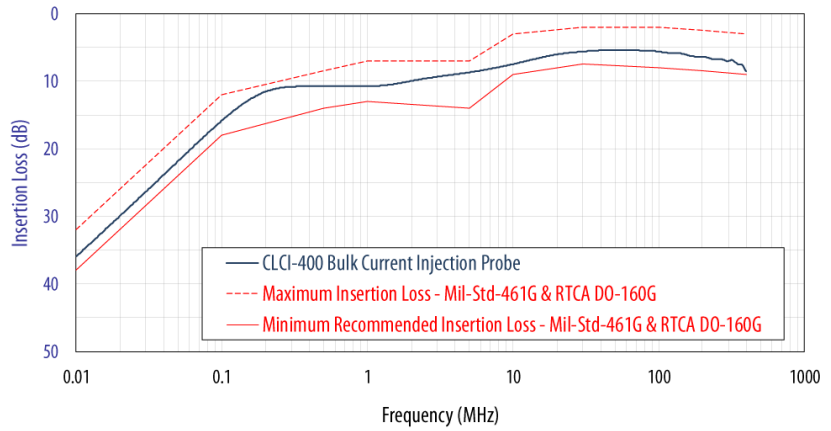

Figure 5 – Typical Insertion Loss for CLCI-400

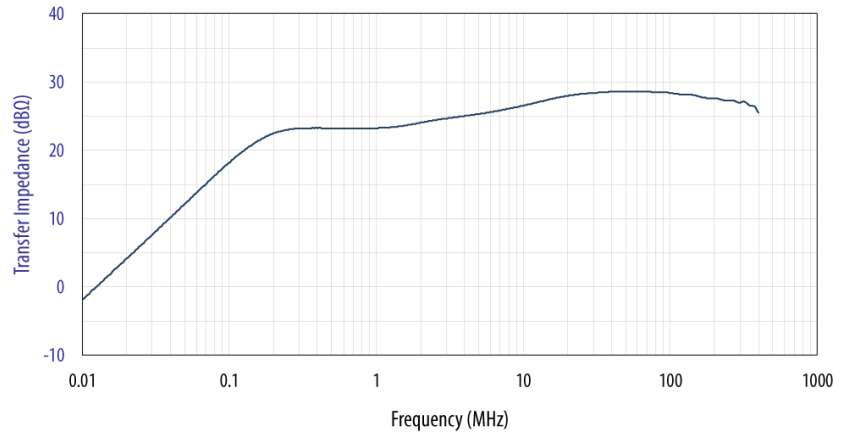

Figure 6 – Typical Transfer Impedance Factors for CLCI-400

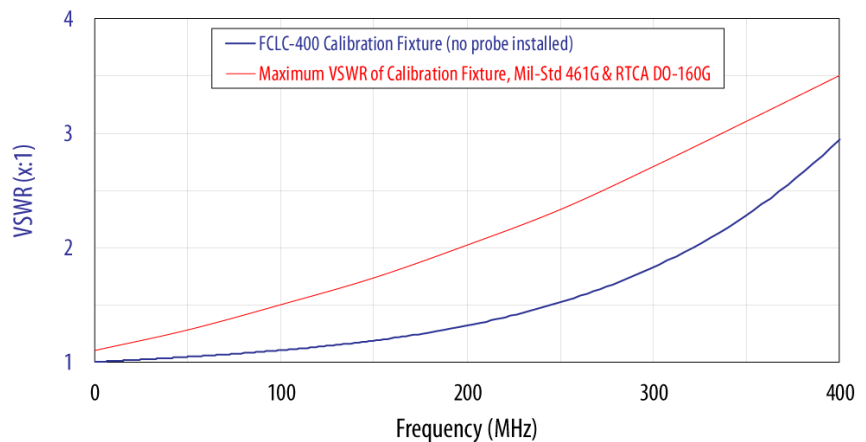

Figure 7 – Typical VSWR of FLC-400 Calibration Fixture

SECTION 3 - PRODUCT INFORMATION

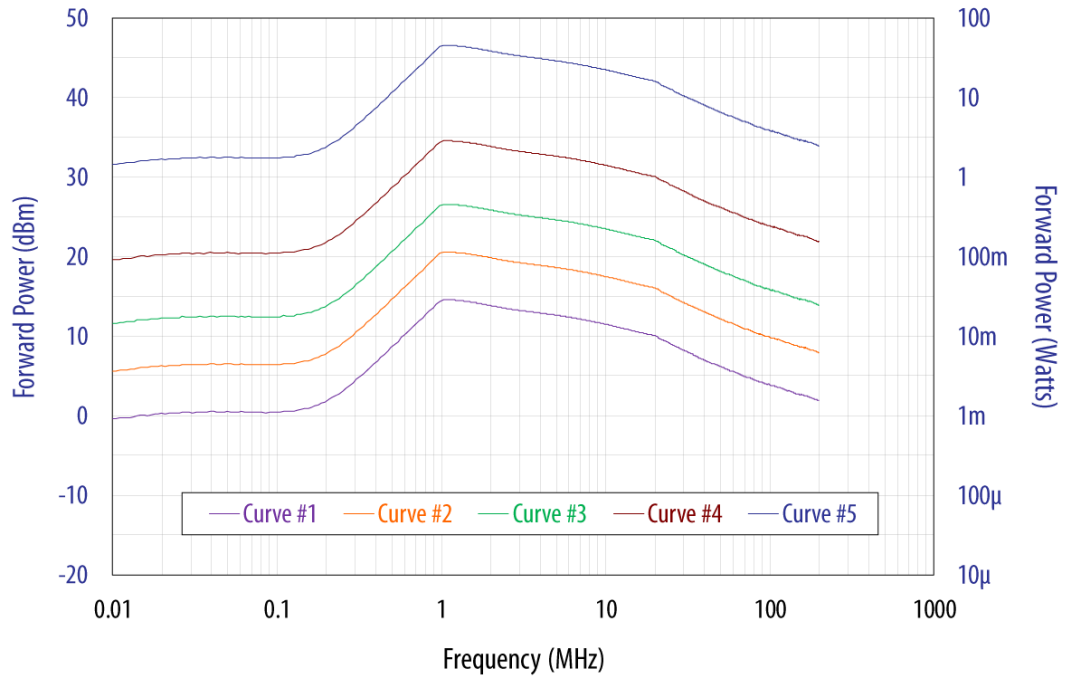

Figure 8 – Typical Forward Power Levels for MIL-STD-461 (CS114)

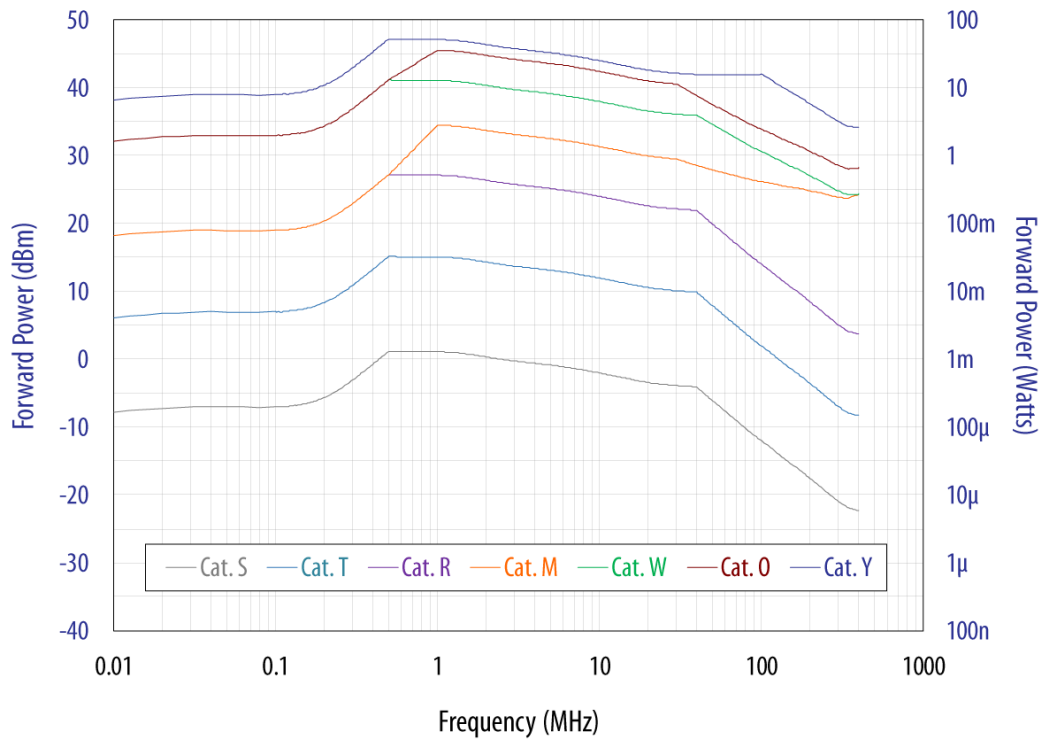

Figure 9 – Typical Forward Power Levels for RTCA DO-160 (Section 20)

SECTION 3 - PRODUCT INFORMATION

4. Calibration

Calibration fixtures provide a means by which current probes, including bulk current injection (BCI) probes, can be calibrated to determine the insertion loss and transfer impedance factors for the probe. Fixtures are also used to establish, or calibrate, drive levels for conducted susceptibility tests performed using BCI probes. These applications are discussed in more detail in the following sections.

The FCLC-400 Fixture is specifically designed for use with the CLCI-400. The intent of the fixture is to maintain the coaxial structure of the transmission line, while allowing the probe to be installed around the center conductor of the coaxial line.

4.1 Installation of CLCI-400 Probe into FCLC-400 Fixture

Illustrated in Figure 10 is the procedure to be followed for installing the CLCI-400 BCI Probe into the FCLC-400 Calibration Fixture.

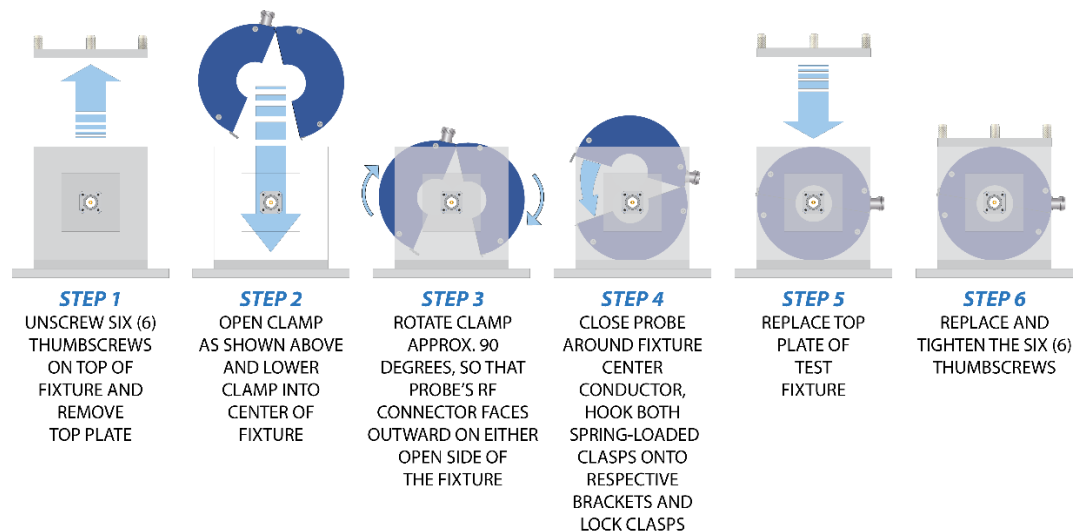

Figure 10 – Installation of CLCI-400 Probe into FCLC-400 Fixture

4.2 Insertion Loss/Transfer Impedance Calibration

4.2.1 Insertion Loss

The insertion loss of a current probe, at any given frequency quantifies the difference between the voltage quantity delivered to the probe's input port and the voltage quantity induced onto the center conductor of the test fixture into which the probe is installed.

For a current monitor probe, a known voltage is applied into one side of the calibration fixture, with the opposite side terminated into 50 ohms; while measuring the voltage present at the output of the probe. The difference between the applied voltage and the measured voltage, at any given frequency, is the insertion loss of the probe.

For an injection probe, a known voltage is applied to the input port of the probe, while measuring the voltage present on one side of the calibration fixture, with the opposite side terminated into 50 ohms. Again, the difference between the applied voltage and the measured voltage, at any given frequency, is the insertion loss of the probe.

Shown in Figure 11 are two equivalent schematic circuits for the two respective measurement methods. The physical test setup showing the equipment and connections is illustrated in Figure 12.

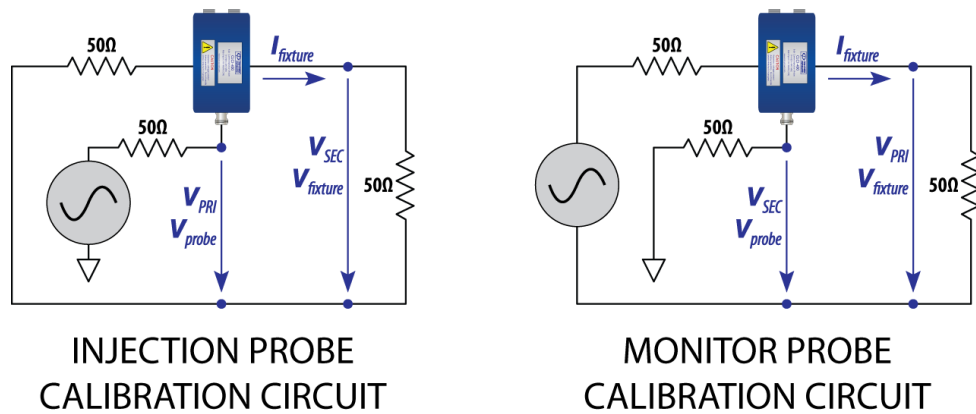

Figure 11 – Equivalent Schematics of the Insertion Loss Calibration Circuits

As measured in either of the circuits shown in Figure 11, the following equation defines the insertion loss of the probe, at any given frequency:

$$\text{Insertion Loss } (L_{ins}) \text{ (in dB)} = \frac{V_{PRI}}{V_{SEC}} = 20 * \log \left(\frac{V_{PRI} \text{ (in Volts)}}{V_{SEC} \text{ (in Volts)}} \right)$$

NOTE: Typical Insertion Loss Values for the CLCI-400 are represented in Figure 5 (Section 3.7).

SECTION 4 - CALIBRATION

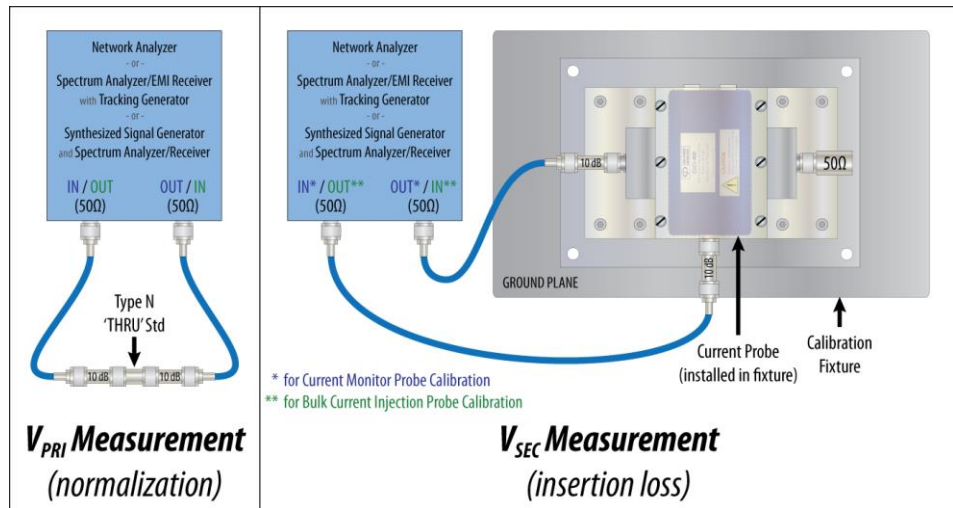

Figure 12 – Test Setup for Insertion Loss Measurement

4.2.2 Transfer Impedance Factors

When the probe is used to measure current, the transfer impedance factors convert the [measured] voltage quantity present at the probe's output port into a current quantity corresponding to the actual current through the conductor(s) passing through the probe aperture.

This factor includes the actual insertion loss of the probe, and also performs the function of converting the measured voltage into a current value. Based on the assumption that the probe is connected to a measuring instrument having a nominal input impedance of 50 ohms, the conversion is simple Ohm's Law:

$$\begin{aligned} \text{Current (in Amps)} &= \left(\frac{\text{Voltage (in Volts)}}{50\Omega} \right) \quad \text{- or -} \quad \text{Current (in dB}\mu\text{A)} = \text{Voltage (in dB}\mu\text{V)} - 20*\log(50\Omega) \\ \text{Current (in dB}\mu\text{A)} &= \text{Voltage (in dB}\mu\text{V)} - 34 \end{aligned}$$

The transfer impedance factors are determined by combining the conversion described above with the insertion loss calibration data, as shown below:

$$\begin{aligned} \text{Transfer Impedance Factor (Z}_T\text{)} &= \left(\frac{V_{SEC}}{V_{PRI}} \right) + 34 = 20*\log\left(\frac{V_{SEC} \text{ (in Volts)}}{V_{PRI} \text{ (in Volts)}} \right) + 34 \\ \text{Transfer Impedance Factor (Z}_T\text{)} &= -\left(L_{ins} \right) + 34 \end{aligned}$$

The transfer impedance factors can be applied in practice, as follows:

$$\text{Current (in dB}\mu\text{A)} = \text{Voltage (in dB}\mu\text{V)} - \text{Transfer Impedance Factor (Z}_T\text{)} \text{ (in dB}\Omega\text{)}$$

SECTION 4 - CALIBRATION

5. Calibration & Test Procedures – MIL-STD-461G (CS114)

The information contained within this section is offered as guidance only. The relevant standards and/or test plans should be consulted to ensure proper application of the tests to be performed. The information provided is based on MIL-STD-461G, and may or may not be appropriate for tests performed according to this or other editions of the standard.

5.1 Test Frequencies

The frequency range of the CS114 test is typically 10 kHz to 200 MHz. This section addresses the determination of the intermediate test frequencies in this range. For the purposes of this document, it is assumed that a 'stepped' frequency scan will be performed. If you are to perform a 'swept' analog scan, refer to the appropriate standard for guidance.

In a stepped scan, the intermediate test frequencies are logarithmically spaced, and determined through calculation according to Table III of MIL-STD-461G, which is summarized in Table 3 below:

Table 3 – Test Frequency Step Size Calculations as per MIL-STD-461, Table III

Frequency Range	Maximum Step Size
30 Hz – 1 MHz	0.05 f_o
1 MHz – 30 MHz	0.01 f_o
30 MHz – 1 GHz	0.005 f_o

Table 4 – Example Test Frequency List – MIL-STD-461G (CS114)

In Table 3, f_o represents the current test frequency. So, if the first test frequency is 10 kHz, the step size to the next test frequency is equal to $0.05 * 10$ kHz, or 500 Hz. Therefore, the second test frequency is 10.5 kHz. The step size to the third test frequency will then be equal to $0.05 * 10.5$ kHz, or 525 Hz; so, the third test frequency is 11.025 kHz; and so forth.

Given in Table 4 is a truncated example of the test frequencies for the respective frequency ranges.

There should be a total of 815 test frequencies for the frequency range of 10 kHz to 200 MHz.

#	Test Freq(s) (MHz)	#	Test Freq(s) (MHz)	#	Test Freq(s) (MHz)
1	0.01	97	1.04065	436	30.2061
2	0.0105	98	1.05106	437	30.3572
3	0.01103	99	1.06157	438	30.509
4	0.01158	100	1.07218	439	30.6615
5	0.01216	101	1.0829	440	30.8148
	↓		↓		↓
94	0.93455	433	29.4636	813	198.016
95	0.98128	434	29.7583	814	199.006
96	1.03035	435	30.0559	815	200

5.2 Test Levels

There are five severity levels at which the CS114 test can be performed (Curves 1 through 5). Refer to Table VI of the appropriate MIL-STD-461 document to determine the appropriate curve for your application. Curves 1 through 5 are defined in Figure CS114-1, and in Figure 13 below.

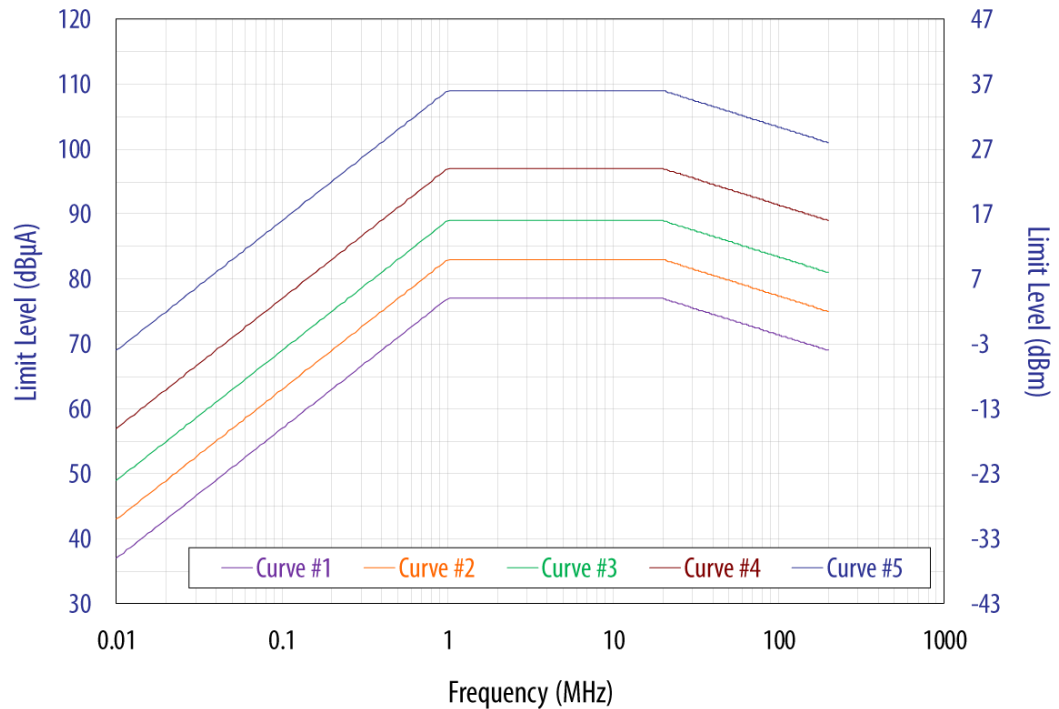

Figure 13 – Calibration Levels – MIL-STD-461G (CS114)

As shown in Figure 13, each curve begins at 10 kHz, ascending linearly with the logarithm of frequency at a rate of 20 dB/decade until it reaches 1 MHz. Each curve remains at a constant amplitude between 1 MHz and 20 MHz; and then ascends linearly with the logarithm of frequency at a rate of 8 dB/decade until it ends at 200 MHz.

The value at any point on either slope can be calculated using the values and formulas shown in Table 5.

Table 5 – Calibration Levels – MIL-STD-461G (CS114)

Freq. Range (MHz)	Slope (m)	Y-intercept (c) or Test Level	Test Level (in dBµA) = ((m) * log(freq. in MHz)) + (c)					Test Level (in dBm) = ((m) * log(freq. in MHz)) + (c)				
			Curve 1	Curve 2	Curve 3	Curve 4	Curve 5	Curve 1	Curve 2	Curve 3	Curve 4	Curve 5
0.01 to 1	20	Y-intercept (c) =	77	83	89	97	109	4	10	16	24	36
1 to 20		Test Level =	77 dBµA	83 dBµA	89 dBµA	97 dBµA	109 dBµA	4 dBm	10 dBm	16 dBm	24 dBm	36 dBm
20-200	-8	Y-intercept (c) =	87.4	93.4	99.4	107.4	119.4	14.4	20.4	26.5	34.4	46.4

SECTION 5 - CALIBRATION & TEST PROCEDURES - MIL-STD-461G (CS114)

5.3 Test Level Calibration Procedure

- 1) Set up the equipment as described in the applicable standard or approved test plan. An example setup diagram is given in Figure 14.

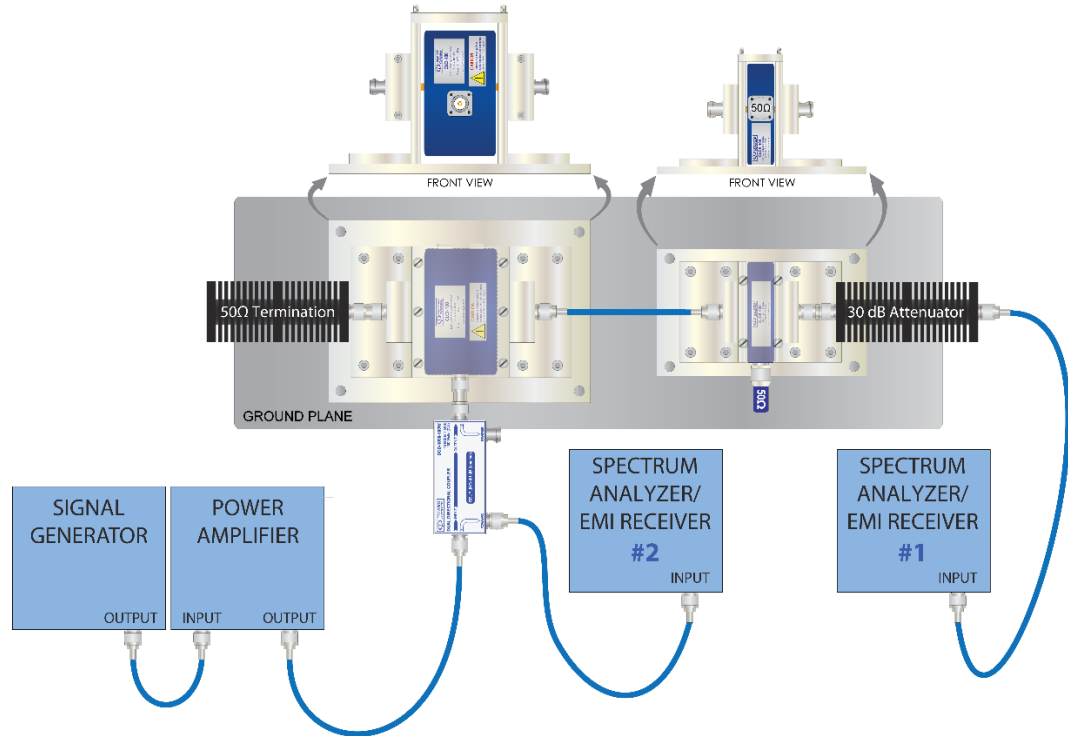

Figure 14 – Example Test Setup Diagram for Calibration of Test Levels

- 2) Turn on all equipment and allow sufficient time for stabilization. Set the frequency of the signal generator and measurement equipment to 10 kHz, unmodulated.
- 3) Slowly increase the amplitude of the signal generator until the value indicated on Spectrum Analyzer/EMI Receiver #1 reaches the appropriate amplitude (see section 5.2).
- 4) Record the present frequency and the measured forward power value indicated on Spectrum Analyzer/EMI Receiver #2.
- 5) Set the frequency of the signal generator and measurement equipment to the next test frequency (see section 5.1).
- 6) Repeat Steps 3-5 until all test frequencies have been calibrated.

NOTE: Typical CS114 Forward Power Levels for the CLCI-400 are shown in Figure 8, in Section 3.7 of this document.

5.4 Verification of Calibration Test Levels Procedure

- 1) Set up the equipment as described in the applicable standard or approved test plan. An example setup diagram is given in Figure 15.

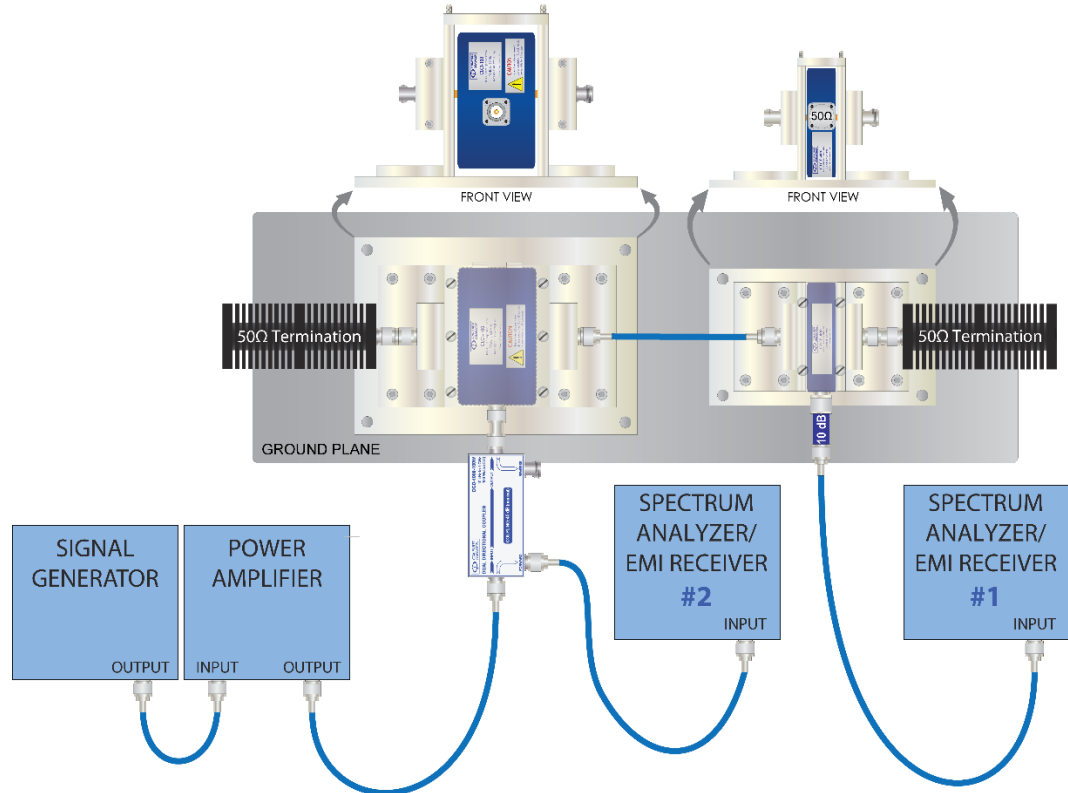

Figure 15 –Example Test Setup Diagram for Verification of Calibration Test Levels

- 2) Turn on all equipment and allow sufficient time for stabilization. Set the frequency of the signal generator and measurement equipment to 10 kHz, unmodulated.
- 3) Adjust the output level of the signal generator until the forward power value indicated on Spectrum Analyzer/EMI Receiver #2 is equal to the respective forward power value recorded during Step 4 of the Test Level Calibration Procedure described in Section 5.3.
- 4) Measure the current present in the calibration circuit by subtracting the Transfer Impedance Factor for the current monitoring probe from the voltage value (in dBμV) measured on Spectrum Analyzer/EMI Receiver #1. The resulting measured current must be within **±3 dB** of the applicable calibration test level (see section 5.2).
- 5) Set the frequency of the signal generator and measurement equipment to the next test frequency (see section 5.1).
- 6) Repeat Steps 3-5 until all test frequencies have been verified.

5.5 EUT Testing Procedure

- 1) Set up the equipment as described in the applicable standard or approved test plan. An example setup diagram is given in Figure 16. Refer to MIL-STD-461G or the applicable test plan to determine the EUT cables to be tested.

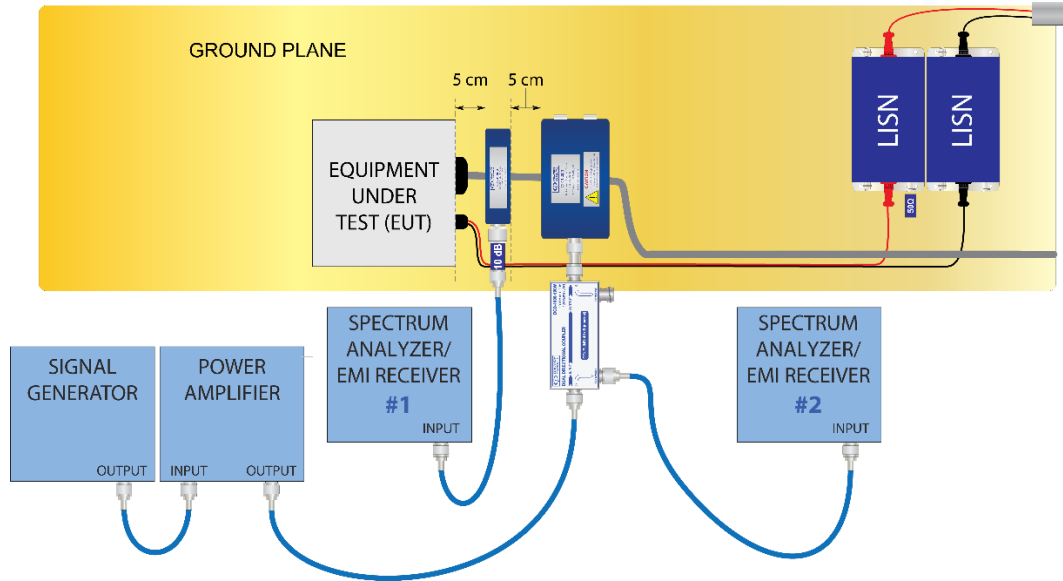

Figure 16 – Example Test Setup Diagram for EUT Testing

- 2) Turn on all EUT equipment and test equipment and allow sufficient time for stabilization. Set the frequency of the signal generator and measurement equipment to 10 kHz with 1 kHz pulse modulation, 50% duty cycle. Verify that the modulation is present on the drive signal and that modulation frequency, waveform and depth (40 dB minimum from peak to baseline) are correct.
- 3) Without exceeding the maximum current level for the applicable limit (refer to Table 6 below), adjust the output level of the signal generator until the forward power value indicated on Spectrum Analyzer/EMI Receiver #2 is equal to the respective forward power recorded during Step 4 of the Test Level Calibration Procedure described in Section 5.3.

Table 6 – Maximum Current Levels – MIL-STD-461G (CS114)

Maximum Current Level (dBµA)				
Curve 1	Curve 2	Curve 3	Curve 4	Curve 5
83	89	95	103	115

- 4) Monitor the EUT for degradation of performance; and, whenever susceptibility is noted, determine the threshold level in accordance with Section 4.3.10.4.3 of MIL-STD-461G.
- 5) Set the frequency of the signal generator and measurement equipment to the next test frequency.
- 6) Repeat Steps 3-5 until the test has been performed at all test frequencies.
- 7) Repeat Steps 2-6 until all required EUT cables have been tested.

6. Calibration & Test Procedures – RTCA DO-160G (Section 20)

The information contained within this section is offered as guidance only. The relevant standards and/or test plans should be consulted to ensure proper application of the tests to be performed. The information provided is based on RTCA DO-160G, and may or may not be appropriate for tests performed according to this or other editions of the standard.

6.1 Test Frequencies

Per RTCA DO-160, Section 20.3(c), the test frequencies are calculated based on the number of frequencies per decade, as shown below:

$$f_n + 1 = f_n * 10^{(1/f_d)} \quad - \text{ or -} \quad f_o + 1 = f_o * f_{\text{step}\%}$$

where:

- f_n = a test frequency and $n = 1$ to m
- f_1 = start frequency
- f_m = end frequency
- m = $1 + f_d * \log(f_m/f_1)$ [rounded up to the nearest integer]
- f_d = frequencies/decade = 10 [for frequencies <100 kHz]
= 100 [for frequencies ≥100 kHz]

where:

- f_o = current test frequency
- $f_{\text{step}\%}$ = 1.258925412 [when $f_o < 100$ kHz]
= 1.023292992 [when $f_o \geq 100$ kHz]

Given below in Table 7, is a truncated example of the test frequencies.

Table 7 – Example Test Frequency List – RTCA DO-160G

Test Freq(s)			Test Freq(s)			Test Freq(s)			Test Freq(s)			Test Freq(s)		
#	f_n	(MHz)	#	f_n	(MHz)	#	f_n	(MHz)	#	f_n	(MHz)	#	f_n	(MHz)
1	f_1	0.01	11	f_1	0.1	111	f_1	1	211	f_1	10	311	f_1	100
2	f_2	0.012589	12	f_2	0.101	112	f_2	1.023293	212	f_2	10.23293	312	f_2	102.3293
3	f_3	0.015849	13	f_3	0.10201	113	f_3	1.047129	213	f_3	10.47129	313	f_3	104.7129
4	f_4	0.019953	14	f_4	0.10303	114	f_4	1.071519	214	f_4	10.71519	314	f_4	107.1519
5	f_5	0.025119	15	f_5	0.10406	115	f_5	1.096478	215	f_5	10.96478	315	f_5	109.6478
↓			↓			↓			↓			↓		
9	f_9	0.063096	109	f_9	0.954993	209	f_9	9.549926	309	f_9	95.49926	370	f_{60}	389.0451
10	f_{10}	0.079433	110	f_{100}	0.977237	210	f_{100}	9.772372	310	f_{100}	97.72372	371	f_{61}	398.1072
	f_m	0.1		f_m	1		f_m	10		f_m	100	372	f_{62}	400

There should be a total of 372 test frequencies for the frequency range of 10 kHz to 400 MHz.

6.2 Test Levels

There are seven severity levels at which the RTCA DO-160G, Section 20 conducted susceptibility test can be performed (Categories S, T, R, M, W, O and Y). The category required for a given product may be given in the applicable equipment performance standard, and are defined in Section 20.2 of the DO-160G standard. The test levels for the respective categories are defined in Figure 20-6 of the standard, and are included in Figure 17 below.

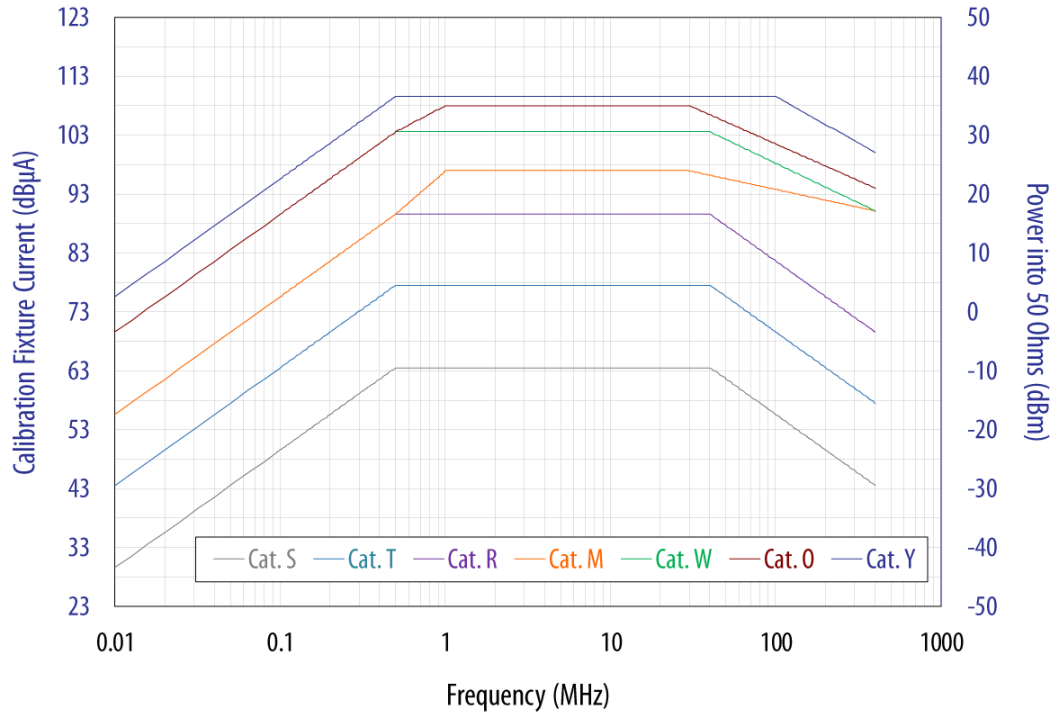

Figure 17 – Calibration Limits – RTCA DO-160G

The value at any frequency point for any category curve on the Figure 17 graph can be determined according to the information provided in Table 8.

Table 8 – Calibration Limits – RTCA DO-160G

Freq. Range (MHz)	Test Level (in dBµA) = ((m) * log[freq.in MHz]) + (c)														Test Level (in dBm) = ((m) * log[freq.in MHz]) + (c)														
	Cat. S		Cat. T		Cat. R		Cat. M		Cat. W		Cat. O		Cat. Y		Cat. S		Cat. T		Cat. R		Cat. M		Cat. W		Cat. O		Cat. Y		
	slope (m)	Y-int. (c)	slope (m)	Y-int. (c)	slope (m)	Y-int. (c)	slope (m)	Y-int. (c)	slope (m)	Y-int. (c)	slope (m)	Y-int. (c)	slope (m)	Y-int. (c)	slope (m)	Y-int. (c)	slope (m)	Y-int. (c)	slope (m)	Y-int. (c)	slope (m)	Y-int. (c)	slope (m)	Y-int. (c)	slope (m)	Y-int. (c)	slope (m)	Y-int. (c)	
0.01 to 0.5	20	69.5	20	83.5	20	95.6	20	95.6	20	109.5	20	109.5	20	115.6	20	-3.5	20	10.5	20	22.6	20	22.6	20	36.5	20	36.5	20	42.6	
0.5 to 1	↑	↑	↑	↑	↑	↑	↑	24.4	96.9	↑	↑	↑	14.7	108	↑	↑	↑	↑	↑	↑	24.4	23.9	↑	↑	14.7	34.9	↑	↑	
1 to 30	63.5 dBµA		77.5 dBµA		89.5 dBµA		96.9 dBµA		103.5 dBµA		108.0 dBµA		109.5 dBµA		-9.5 dBm		4.5 dBm		16.5 dBm		23.9 dBm		30.5 dBm		34.9 dBm		36.5 dBm		
30 to 40	↓	↓	↓	↓	↓	↓	↓	↑	↑	↓	↓	↓	↓	↓	↓	↓	↓	↓	↓	↓	↑	↑	↑	↑	↑	↑	↑	↑	
40 to 100	-20	95.6	-20	109.5	-20	121.6	-6	105.8	-13.4	125	-12.4	126.3	↑	↑	-20	22.6	-20	36.5	-20	48.6	-6	32.8	-13.4	52	-12.4	53.3	↑	↑	
100 to 400	↓	↓	↓	↓	↓	↓	↓	↓	↓	↓	↓	↓	-15.8	141.2	↓	↓	↓	↓	↓	↓	↓	↓	↓	↓	↓	↓	↓	-15.8	68.2

SECTION 6 - CALIBRATION & TEST PROCEDURES – RTCA DO-160 (Section 20)

6.3 Test Level Calibration Procedure

- 1) Set up the equipment as described in the applicable standard or approved test plan. An example setup diagram is given in Figure 18.

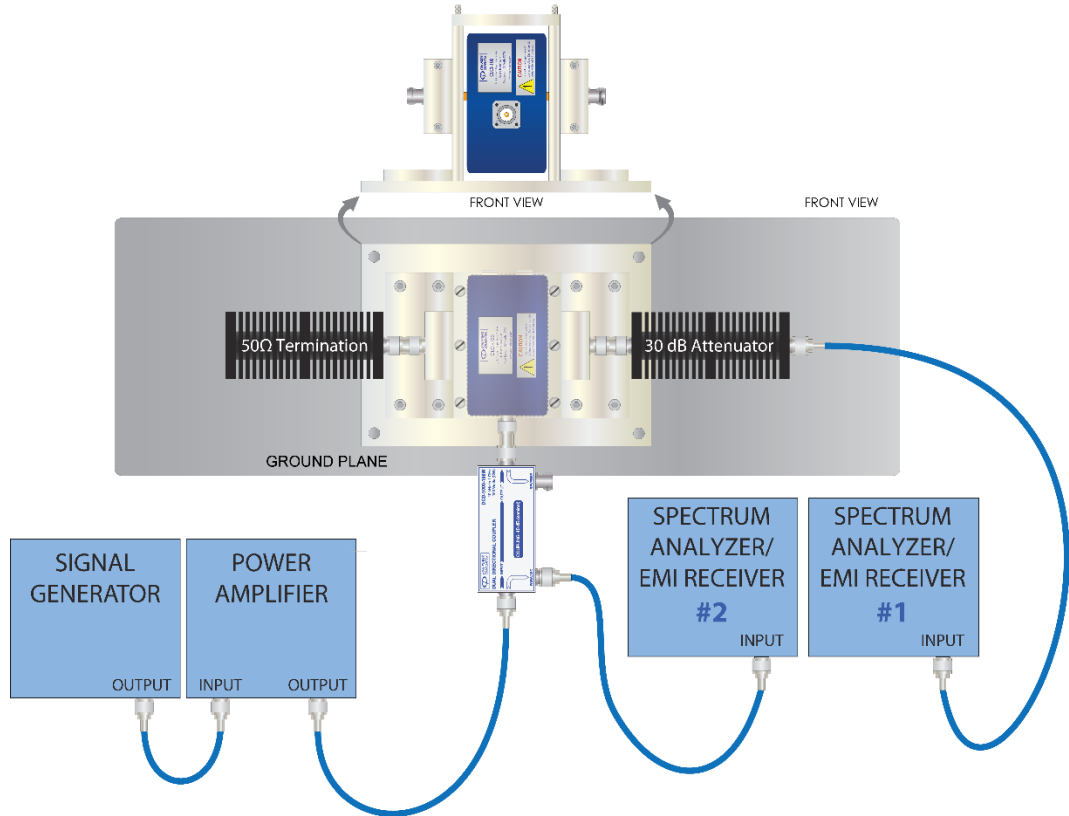

Figure 18 –Example Test Setup Diagram for Calibration of Test Levels

- 2) Turn on all equipment and allow sufficient time for stabilization. Set the frequency of the signal generator and measurement equipment to 10 kHz, unmodulated.
- 3) Slowly increase the amplitude of the signal generator until the value indicated on Spectrum Analyzer/EMI Receiver #1 reaches the appropriate amplitude (see section 6.2).
- 4) Record the present frequency and the measured forward power value indicated on Spectrum Analyzer/EMI Receiver #2.
- 5) Set the frequency of the signal generator and measurement equipment to the next test frequency (see section 6.1).
- 6) Repeat Steps 3-5 until all test frequencies have been calibrated.

NOTE: Typical DO-160, Section 20 Forward Power Levels for the CLCI-400 are shown in Figure 9, in Section 3.7 of this document.

6.4 EUT Testing Procedure

- 1) Set up the equipment as described in the applicable standard or approved test plan. An example setup diagram is given in Figure 19. Refer to RTCA DO-160 or the applicable test plan to determine the EUT cables to be tested.

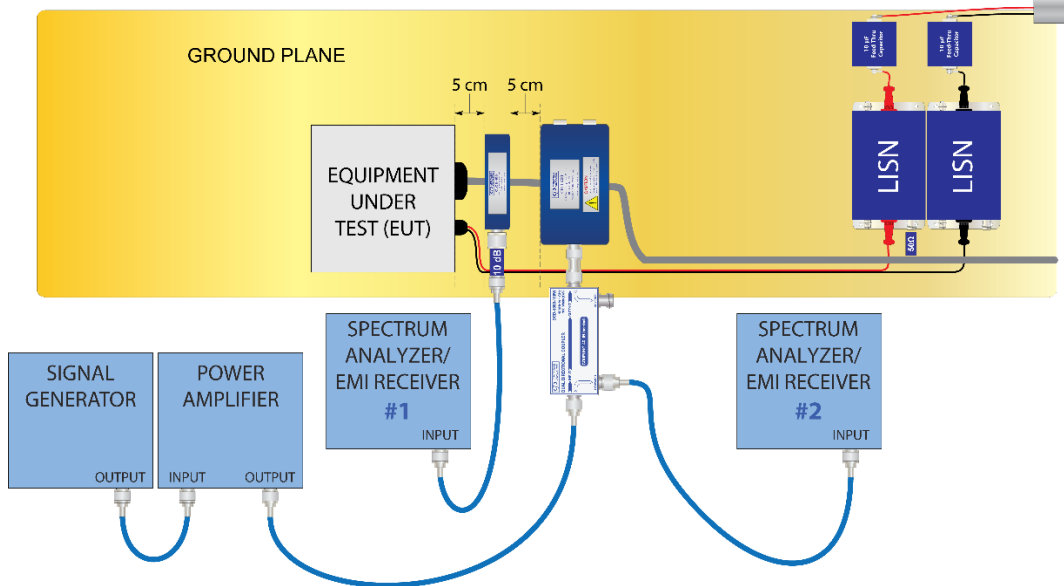

Figure 19 –Example Test Setup Diagram for EUT Testing

- 2) Turn on all EUT equipment and test equipment and allow sufficient time for stabilization. Set the frequency of the signal generator and measurement equipment to 10 kHz with 1 kHz square wave modulation, with at least 90% depth. Verify that the modulation is present on the drive signal and that modulation frequency, waveform and depth are correct.
- 3) Adjust and control the forward power to achieve the induced current on the cable bundle for the selected category level (see section 6.2). When necessary, limit the forward power to not more than **6 dB** above the calibration value recorded during Step 4 of the Test Level Calibration Procedure described in Section 6.3. Record the induced current and applied forward power in the test report.
- 4) Evaluate EUT operation and determine compliance with applicable equipment performance standards.
- 5) Set the frequency of the signal generator and measurement equipment to the next test frequency.
- 6) Repeat Steps 3-5 until the test has been performed at all test frequencies.
- 7) Repeat Steps 2-6 until all required EUT cables have been tested.

7. Warranty

Com-Power warrants to its Customers that the products it manufactures will be free from defects in materials and workmanship for a period of three (3) years. This warranty shall not apply to:

- Transport damages during shipment from your plant.
- Damages due to poor packaging.
- Products operated outside their specifications.
- Products Improperly maintained or modified.
- Consumable items such as fuses, power cords, cables, etc.
- Normal wear
- Calibration
- Products shipped outside the United States without the prior knowledge of Com-Power.

In addition, Com-Power shall not be obliged to provide service under this warranty to repair damage resulting from attempts to install, repair, service or modify the instrument by personnel other than Com-Power service representatives.

Under no circumstances does Com-Power recognize or assume liability for any loss, damage or expense arising, either directly or indirectly, from the use or handling of this product, or any inability to use this product separately or in combination with any other equipment.

When requesting warranty services, it is recommended that the original packaging material be used for shipping. Damage due to improper packaging will void warranty.

In the case of repair or complaint, Please visit our website www.com-power.com and fill out the service request form (<http://com-power.com/repairservicereq.asp>). Our technical assistance personnel will contact you with an RMA number. The RMA number should be displayed in a prominent location on the packaging and on the product, along with a description of the problem, and your contact information.

SECTION 7 - WARRANTY

8. Maintenance

This product contains no user serviceable parts. If the unit does not operate or needs calibration, please contact Com-Power Corporation. Any modifications or repairs performed on the unit by someone other than an authorized factory trained technician will void warranty.

The exterior surface may be cleaned with mild detergent and then be wiped with a dry, clean, lint-free cloth. Use care to avoid liquids or other foreign objects entering the chassis.